

BO-322A-0101

使用説明書

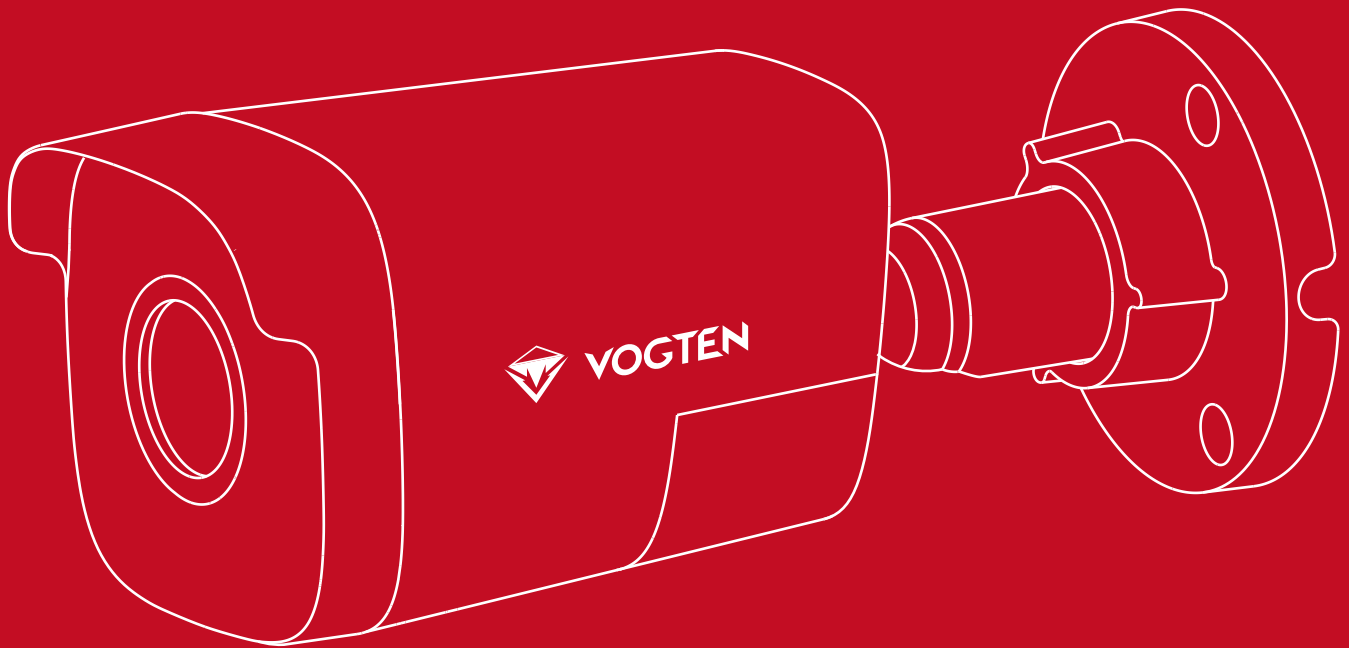

包裝內容:

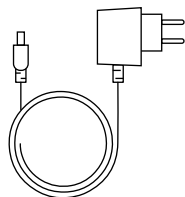

電源線

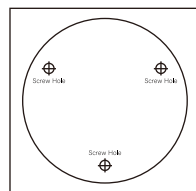

鑽孔貼紙

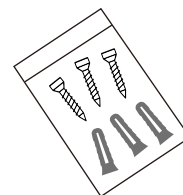

螺絲組

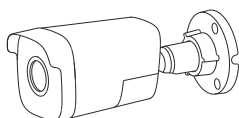

攝影機

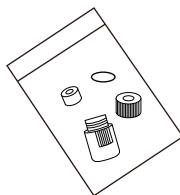

網路尾線防水帽

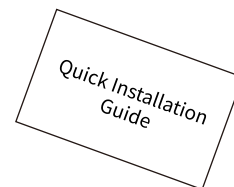

快速指南

基本元件

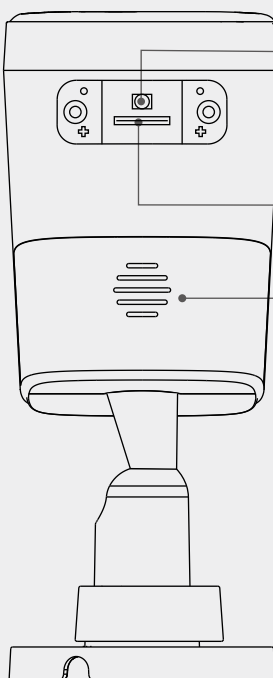

【按4秒】-連接手機裝置

【按8秒】-重置攝影機



01/安裝Micro SD卡(選購)

- 1 用螺絲起子將卡片插槽打開。
- 2 將Micro SD卡插入卡片插槽，如下圖所示。

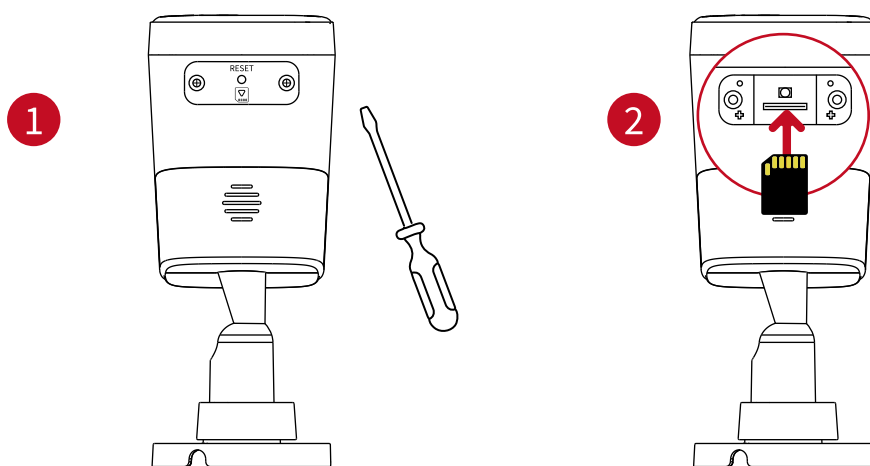

02/安裝攝影機

- △請確認天花板的強度，足以承受三倍攝影機重量。
- △避免將攝影機放置在許多光線直接照射攝影機鏡頭的區域。

- 1 拿出鑽孔模板，粘貼到選擇安裝表面上。
- 2 依據模板鑽出螺絲孔，再插入三個膨脹螺絲。
- 3 使用三顆螺絲釘固定底座。

02-1/線露出於牆壁外

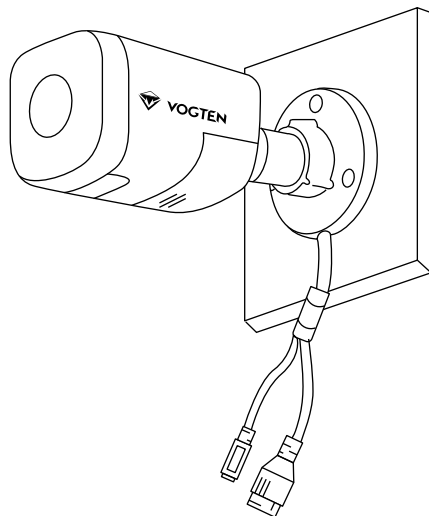

1

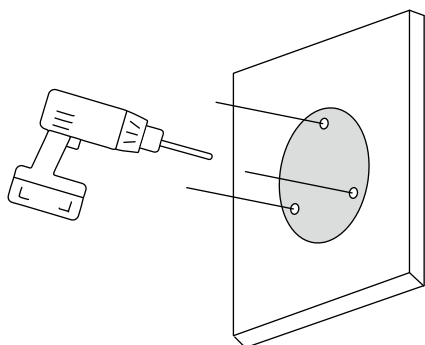

2

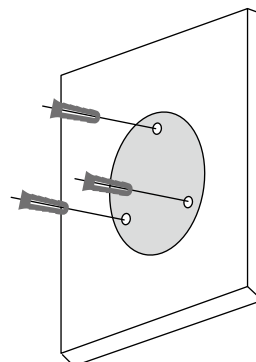

3

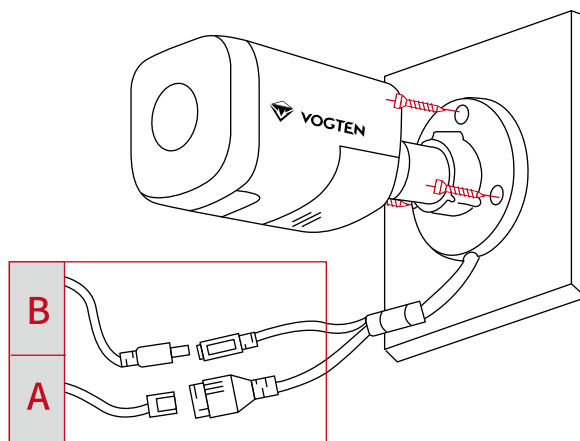

02-2/線嵌入於牆壁內

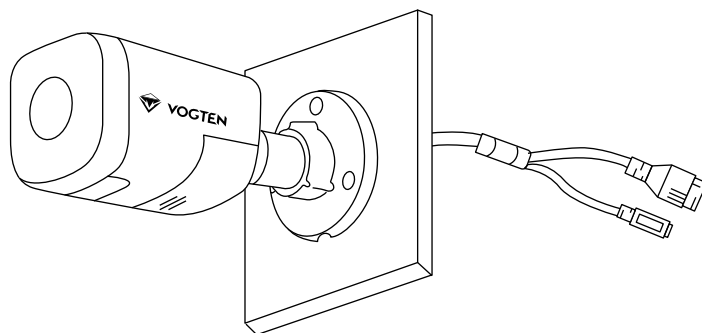

1

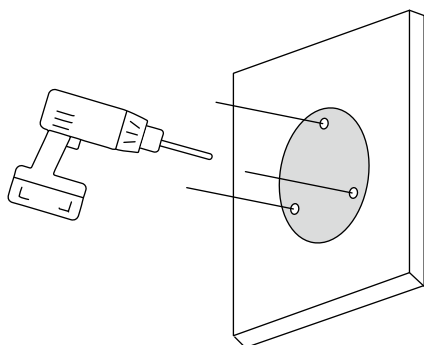

2

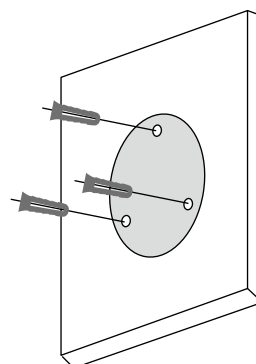

3

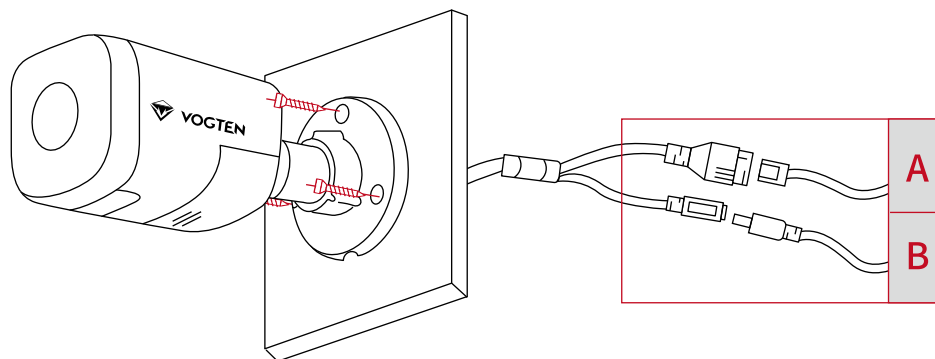

A 防水套件安裝

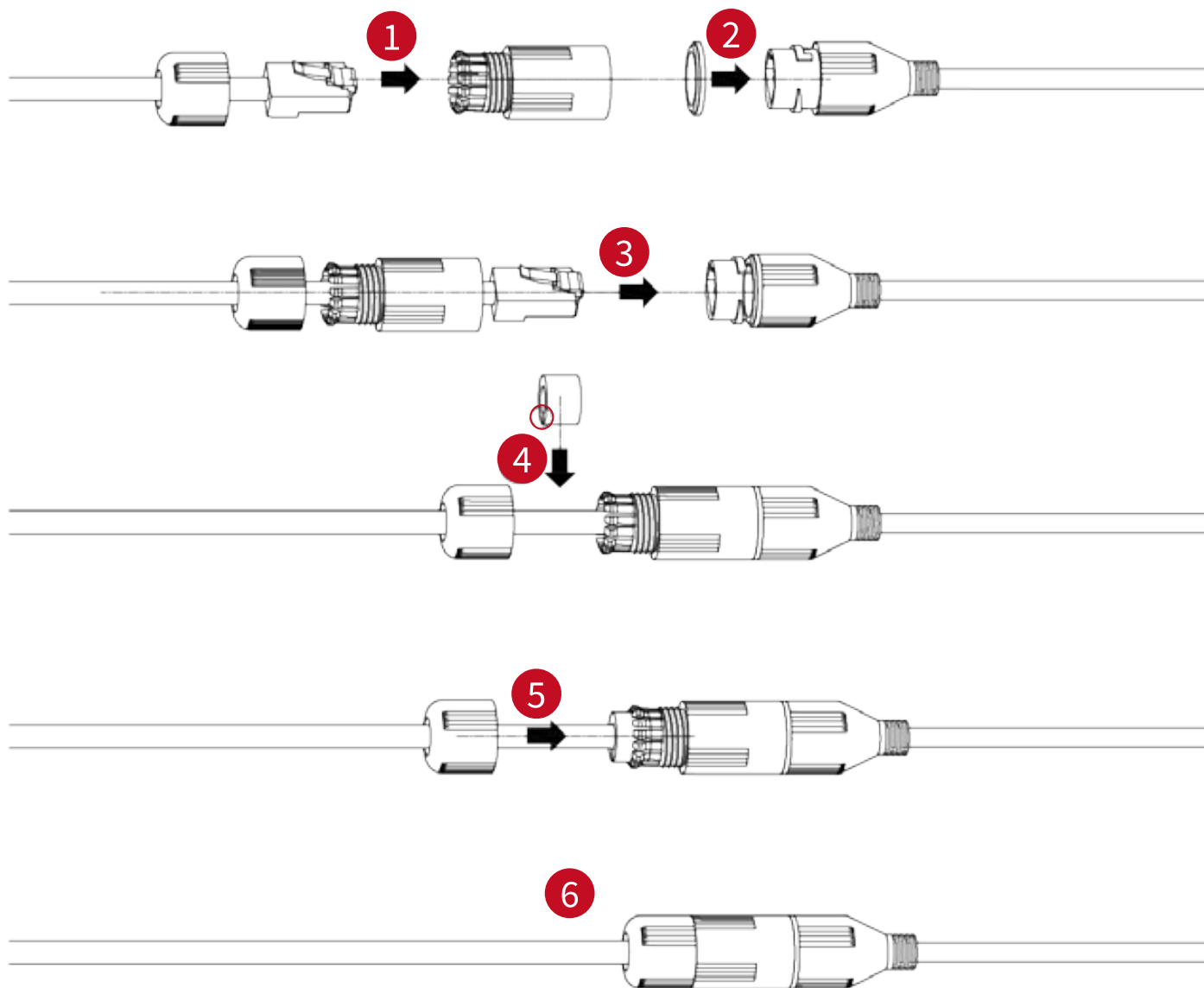

B 電源接頭安裝

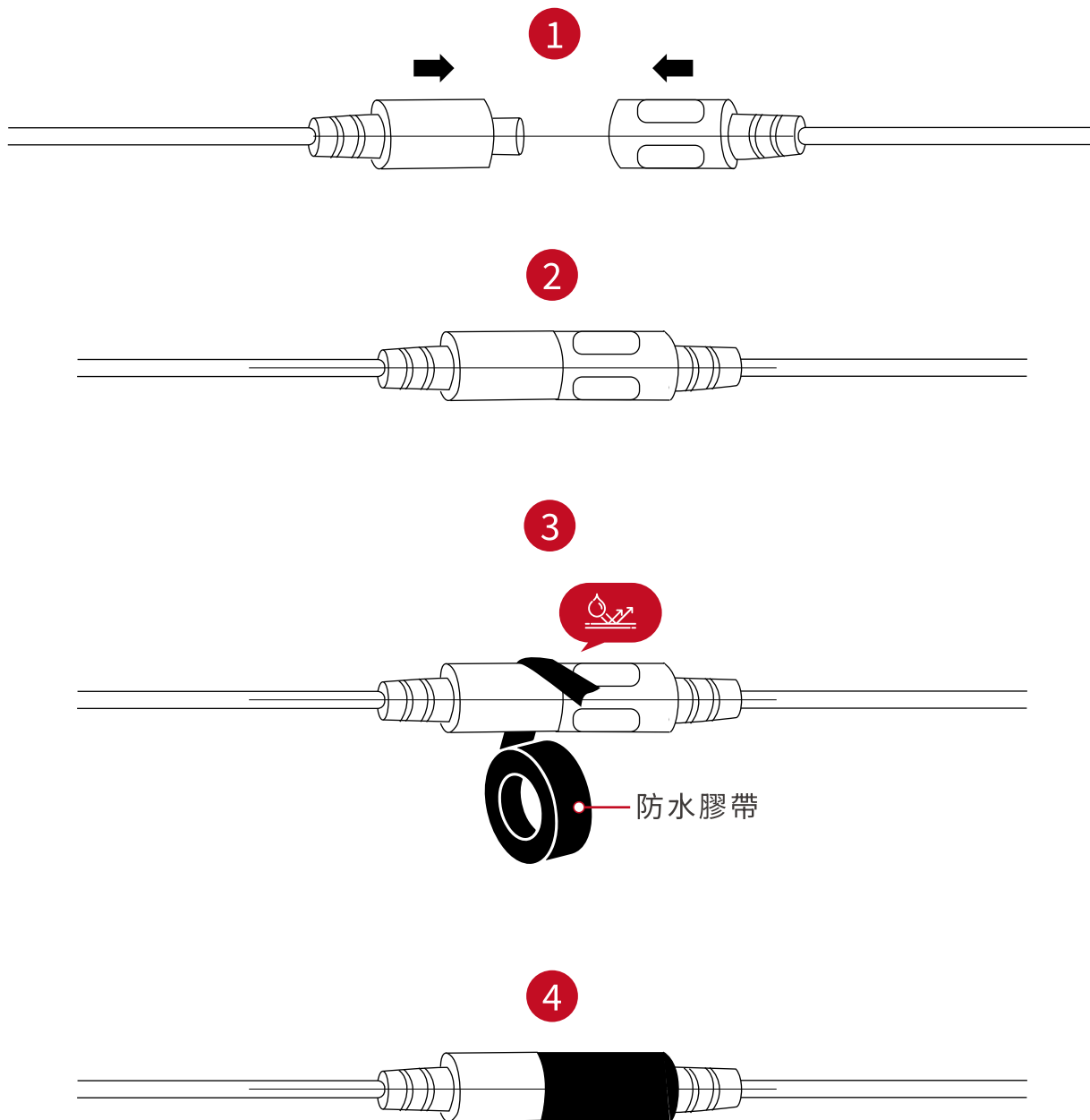

! 如需詳細資訊，請再造訪 <https://vogten.vn/>