

BO-322A-0101

User Manual

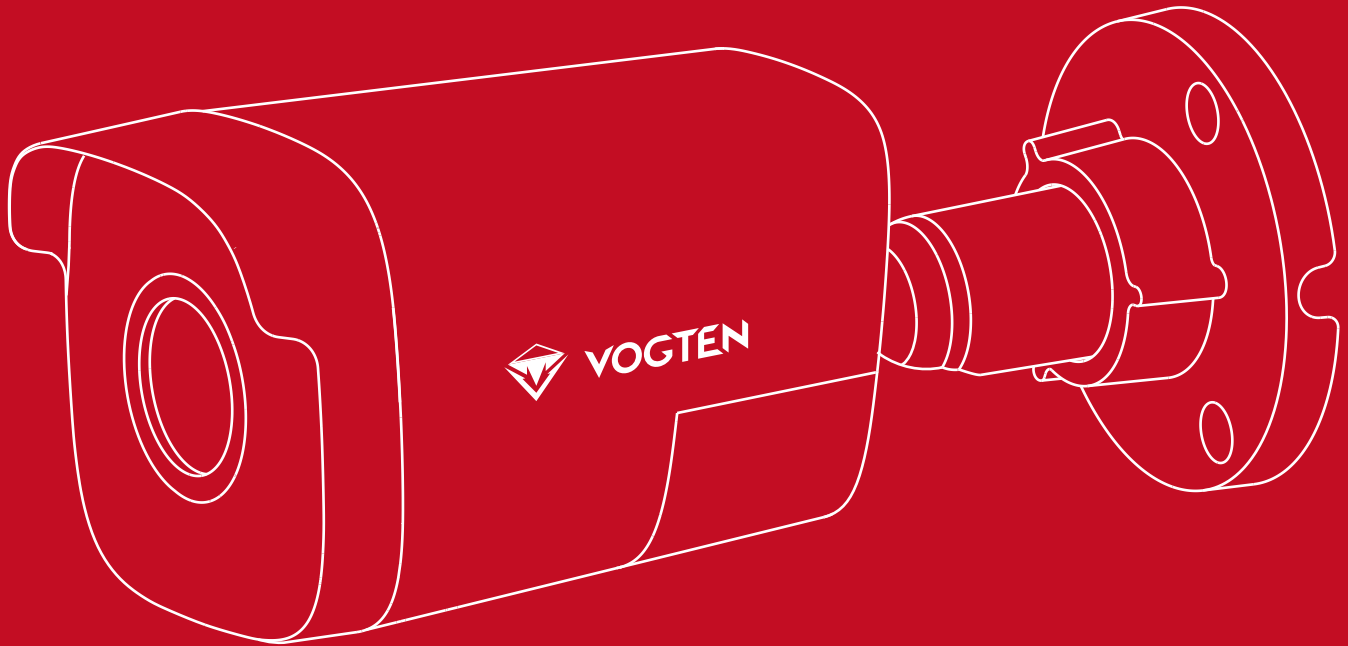

Package Contents

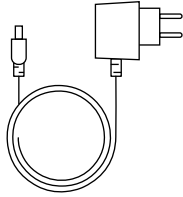

Power cable

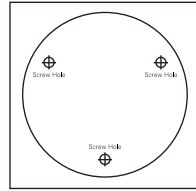

Drill Template

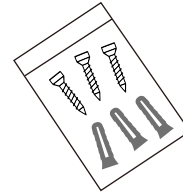

Screw Kit

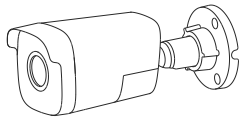

Camera

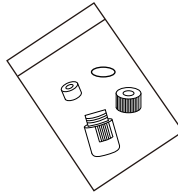

Waterproof Connector

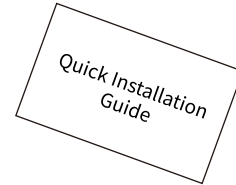

Quick Installation Guide

Basics

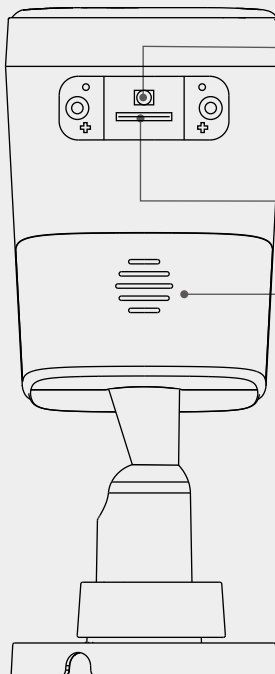

【Press for 4 seconds】
Connect to mobile device

【Press for 8 seconds】
Reset camera



01/ Install the Micro SD Card (Purchase)

- 1 Use a screwdriver to open the card slot.
- 2 Insert the Micro SD card (sold separately) into the card slot as shown in the

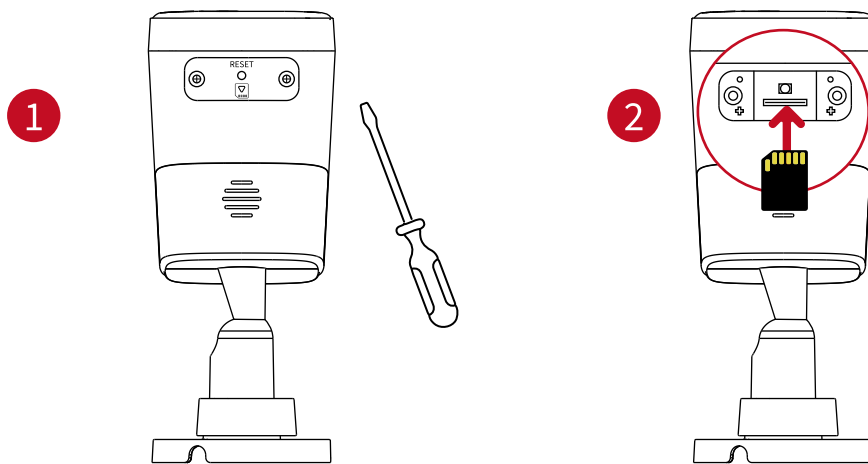

02/ Install the camera

- △ Make sure the ceiling is strong enough to withstand three times the weight of the camera.
- △ Avoid positioning the camera in an area that gets a lot of light shining directly into the camera lens.

- 1 Take out the drilling template and stick it to the chosen installation surface.
- 2 Drill holes according to the drilling template and insert three plastic anchors.
- 3 Use three screws to secure the base.

02-1 / The wire is exposed outside the wall

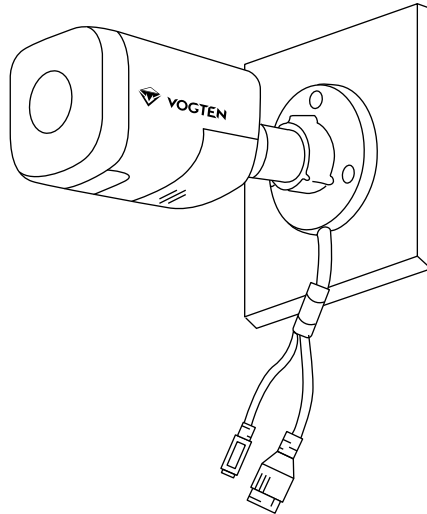

1

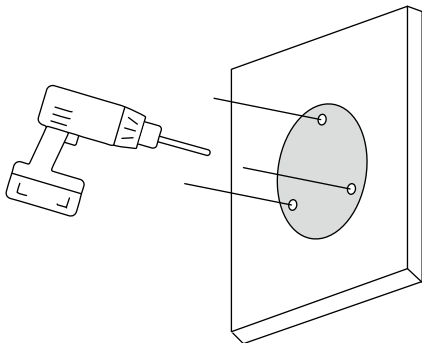

2

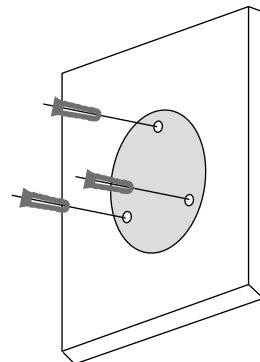

3

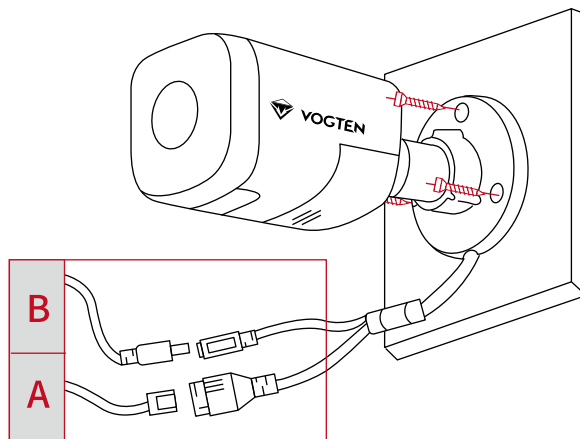

02-2 / The wire is embedded inside the wall

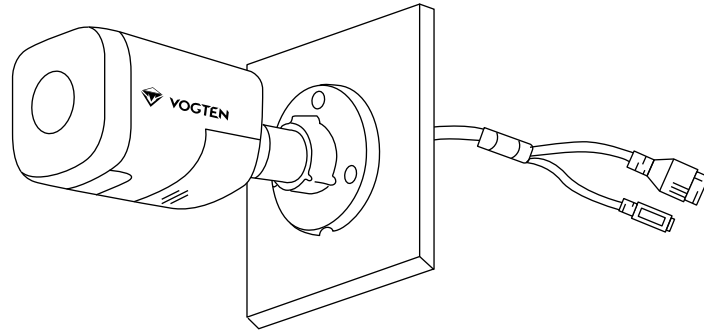

1

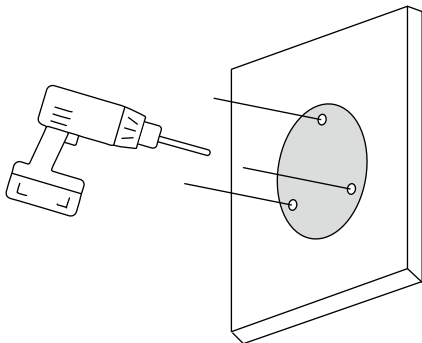

2

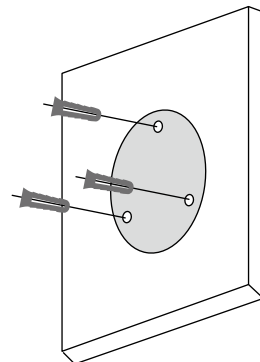

3

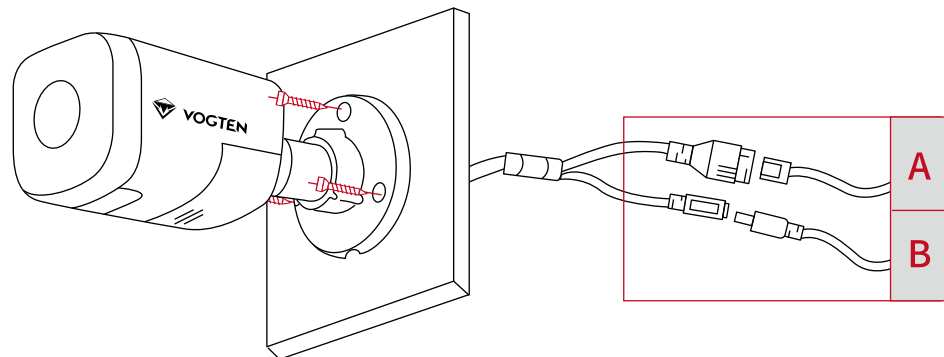

A Waterproof kit installation

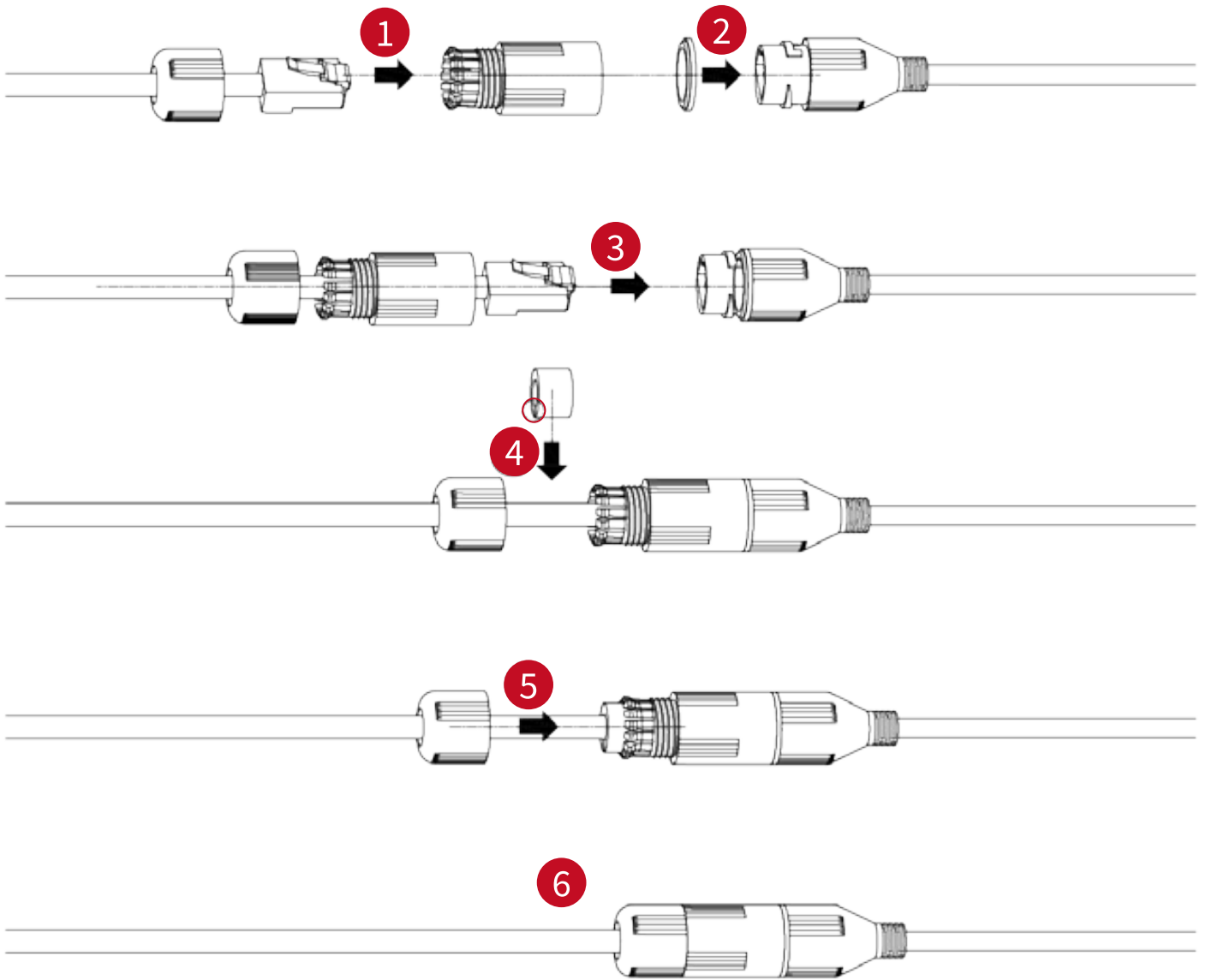

B Power connector installation

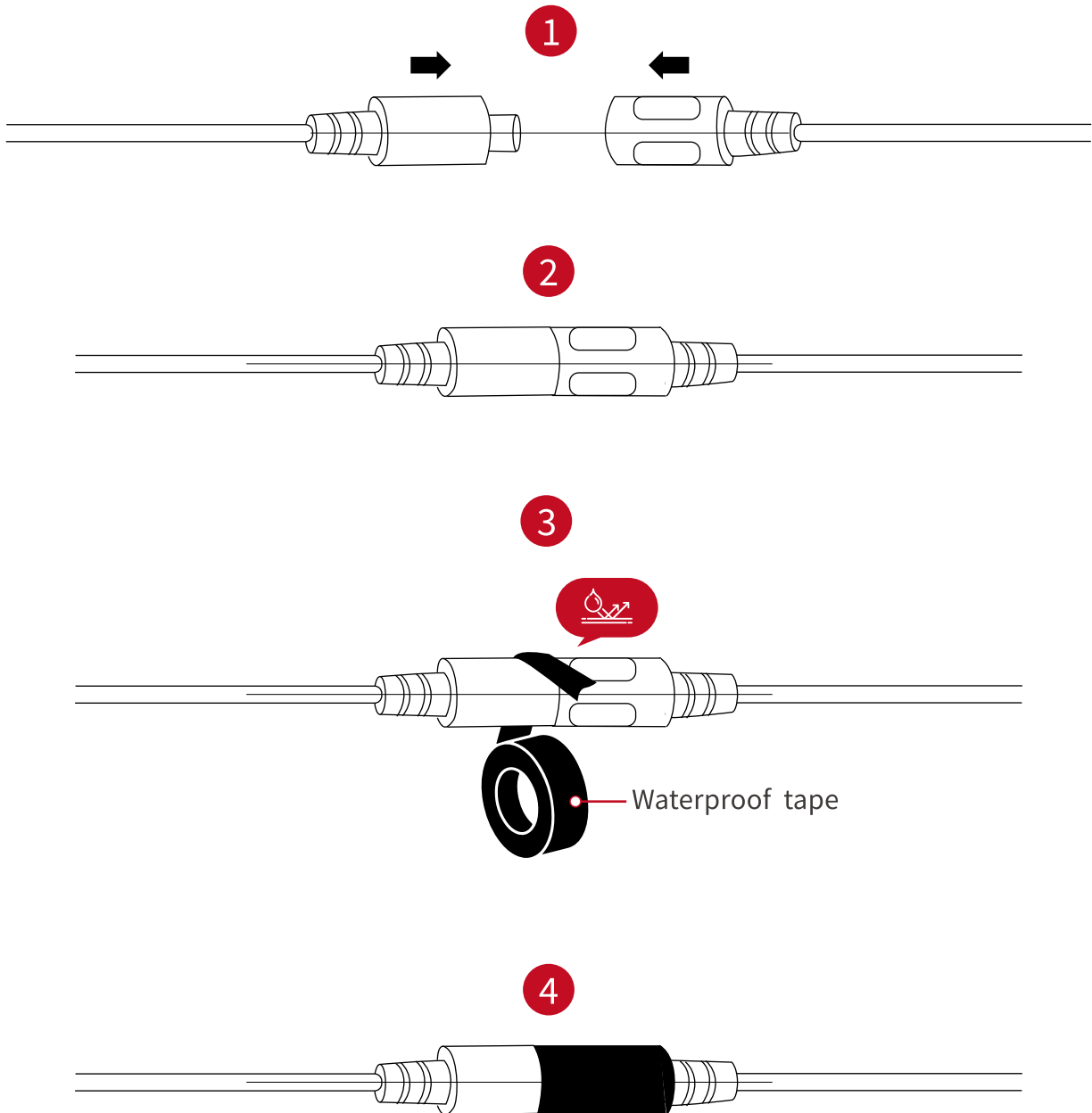

! For detailed information, please visit <https://vogten.vn/>