

# PI-321A-0101

使用説明書

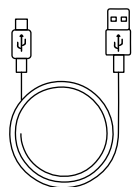

# 包裝內容:



電源線

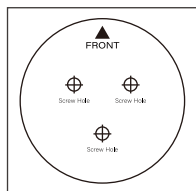

鑽孔貼紙

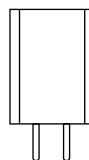

插頭

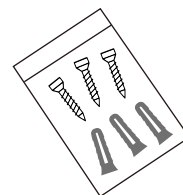

螺絲組

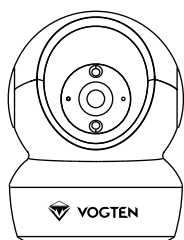

攝影機

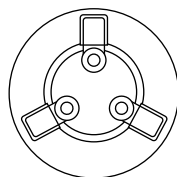

底座

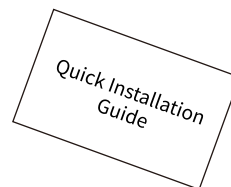

快速指南

## 基本元件

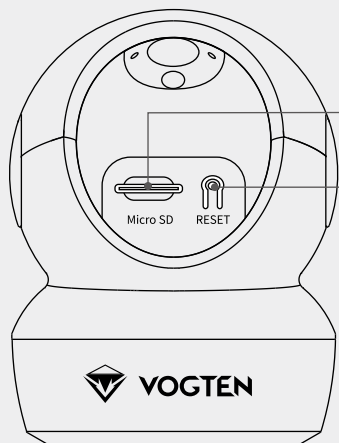

【按4秒】- 連接手機裝置

【按8秒】- 重置攝影機

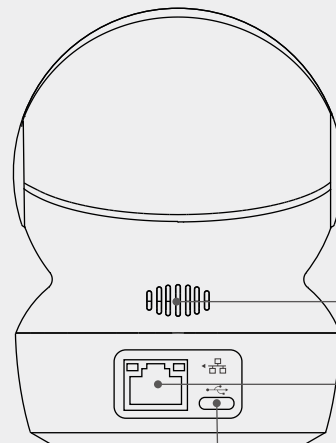

# 設定

## 開啟電源

>將電源線連接至攝影機，再將電源變壓器插入插座。

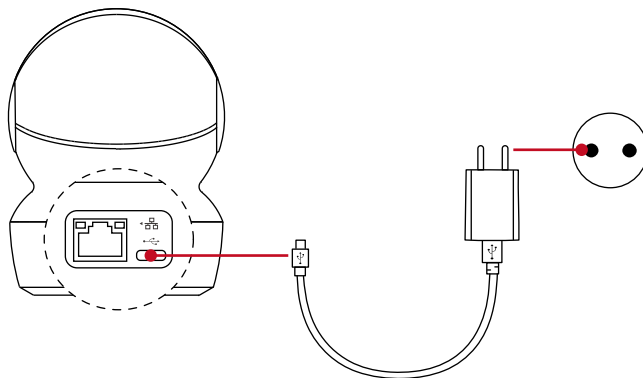

## 01/安裝Micro SD卡(選購)

- 1 將球體往上撥直到看見卡片插槽。
- 2 將Micro SD卡插入卡片插槽，如下圖所示。

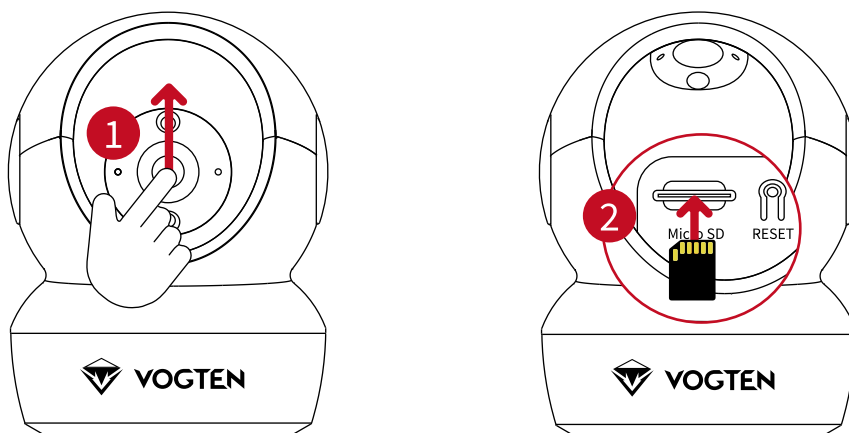

## 02/安裝底座

△請確認天花板的強度，足以承受三倍攝影機重量。

△避免將攝影機放置在許多光線直接照射攝影機鏡頭的區域。

※ 攝影機可以被平放或按裝在天花板【這裡已以安裝天花板為例】

- 1 拿出鑽孔模板，粘貼到選擇安裝表面上。
- 2 依據模板鑽出螺絲孔，再插入三個膨脹螺絲。
- 3 使用三顆螺絲釘固定底座。

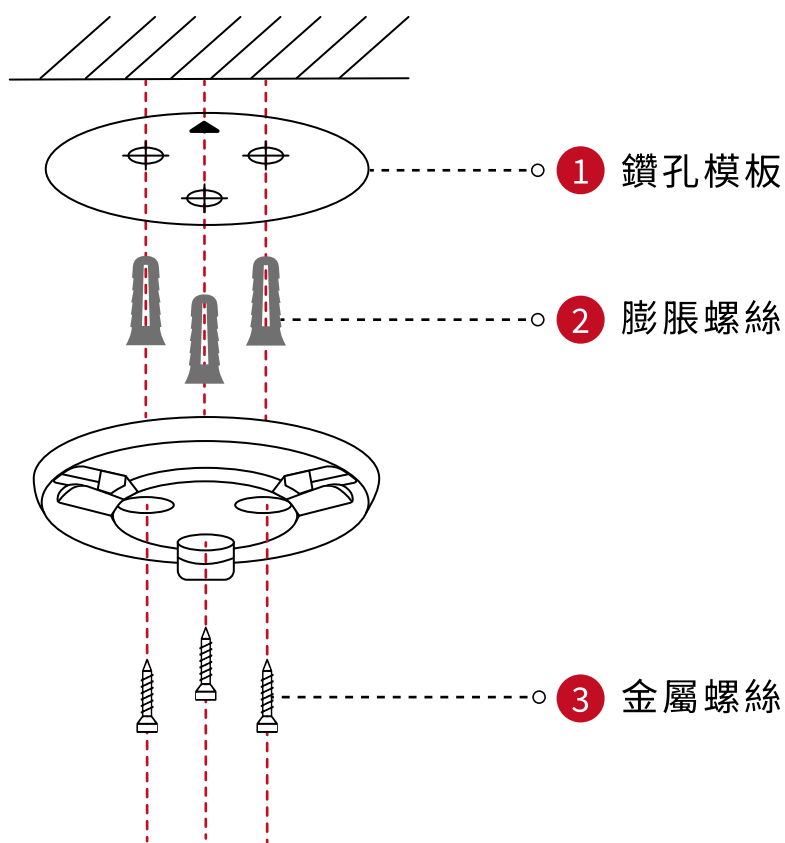

! 必要時，請在安裝底座後拆除鑽孔模板。

## 03/安裝攝影機

> 將攝影機安裝在底座，並以順時針方向旋轉置固定為止。

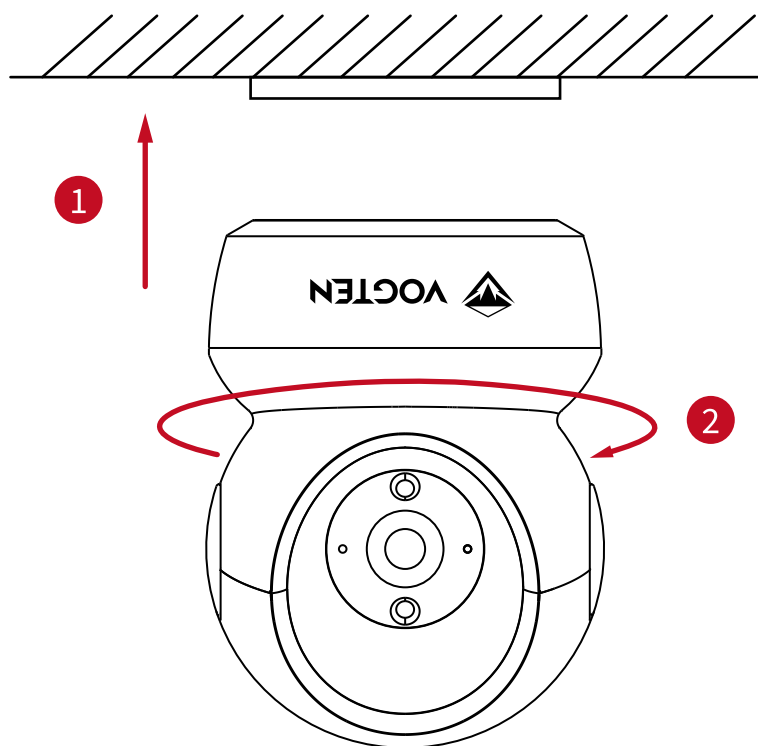

! 如需詳細資訊，請再造訪 <https://vogten.vn/>