

# PI-321A-0101

User Manual

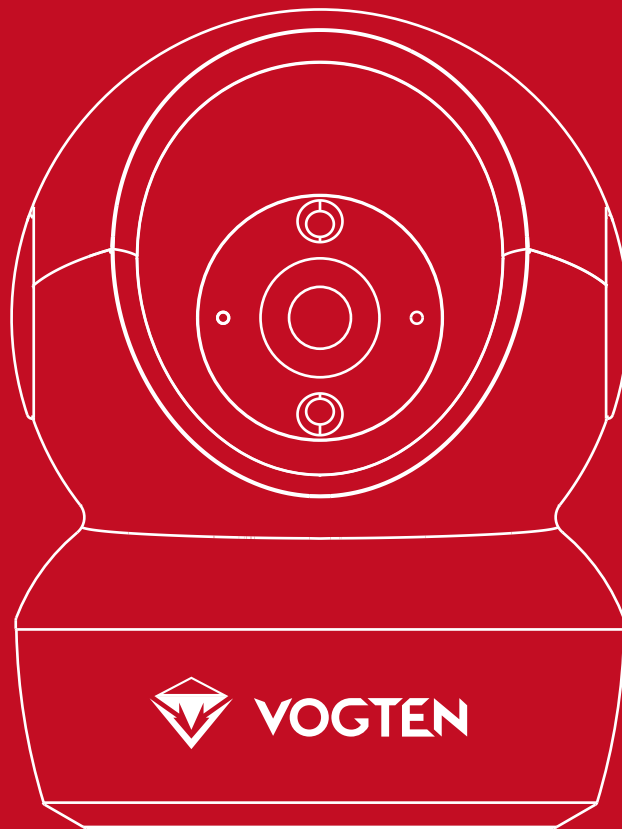

# Package Contents

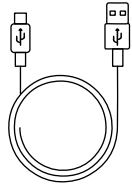

Power Cable

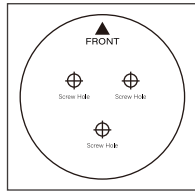

Drill Template

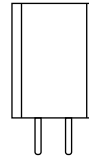

plug

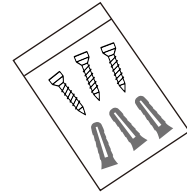

Screw Kit

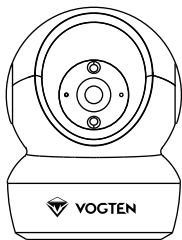

Camera

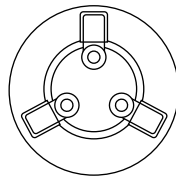

Base

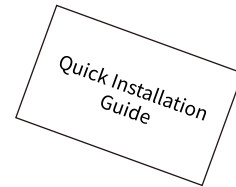

Quick Installation Guide

## Basics

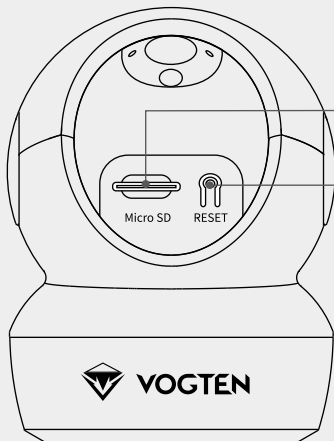

**【Press for 4 seconds】**  
Connect to mobile device

**【Press for 8 seconds】**  
Reset camera

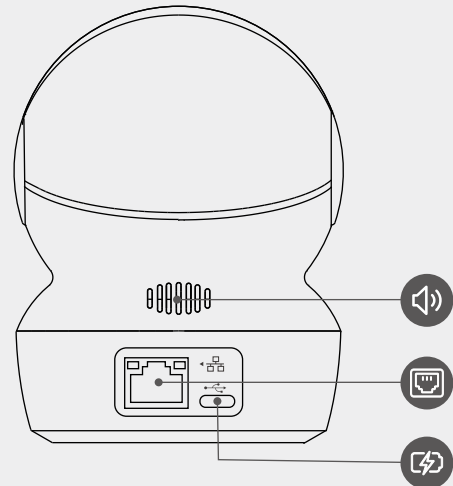

# Setting

## Power-on

Plug the power cable into the camera, and then plug the power adapter into an outlet as shown in the figure below.

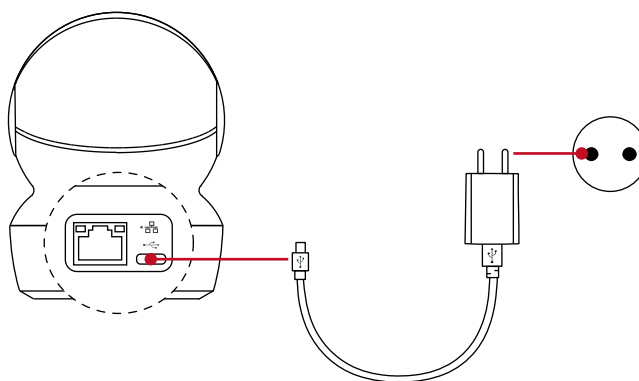

## 01/Install the Micro SD Card (Purchase)

- 1 Rotate the sphere upwards until you see the card slot.
- 2 Insert the Micro SD card (sold separately) into the card slot as shown in the figure below.

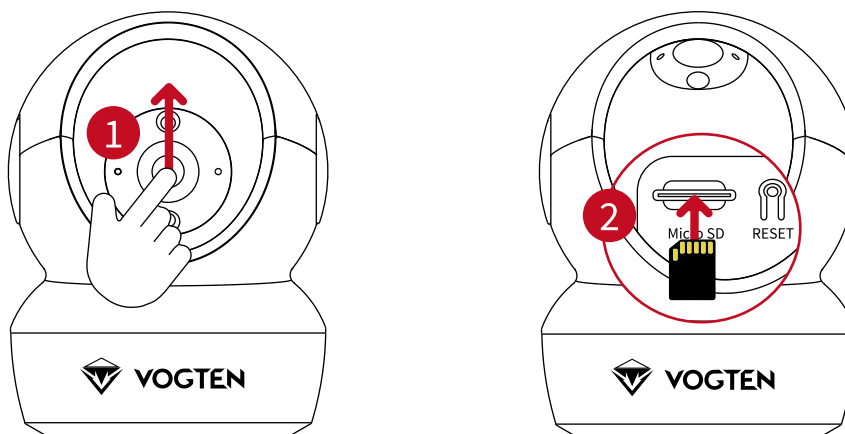

## 02/Install the Base

△ Make sure the ceiling is strong enough to withstand three times the weight of the camera.

△ Avoid positioning the camera in an area that gets a lot of light shining directly into the camera lens.

※ The camera can be placed horizontally or mounted on the ceiling. Here we take ceiling mounting as an example.

- 1 Take out the drilling template and stick it to the chosen installation surface.
- 2 Drill holes according to the drilling template and insert three plastic anchors.
- 3 Use three screws to secure the base.

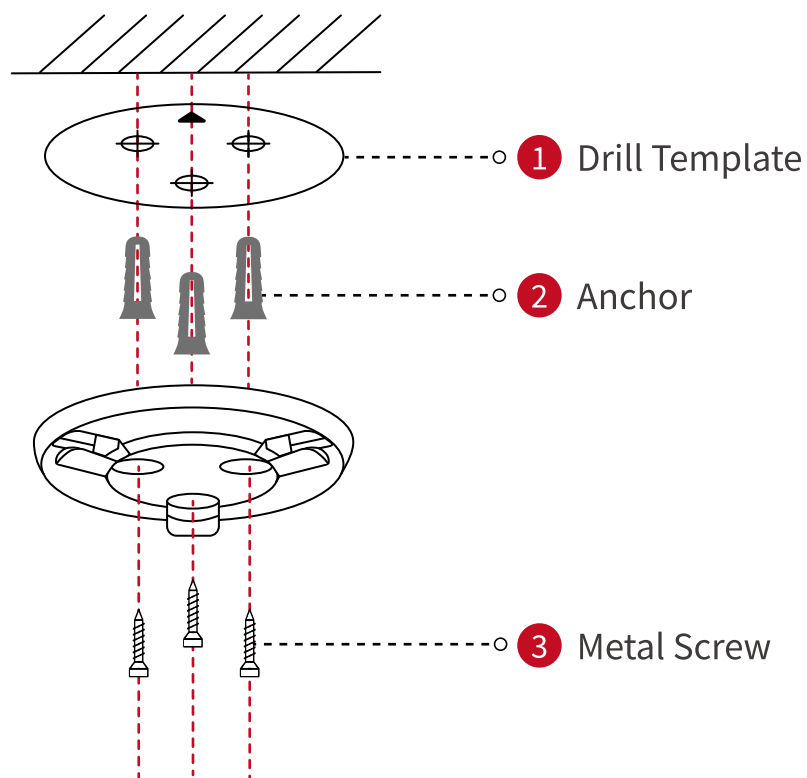

! Please tear up the drill template after installing the base if needed.

## 03/Install the Camera

Mount the camera to the base, and turn it clockwise until it is fixed.

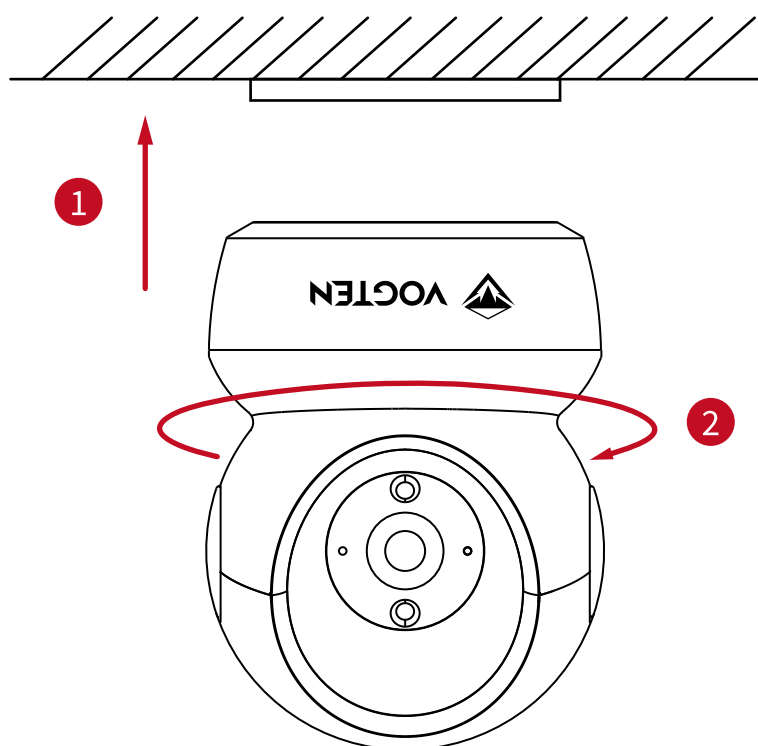

! For detailed information, please visit <https://vogten.vn/>